

**Solid State Logic**



Super-Analogue™ Outboard

Owner's Manual

---

# Solid State Logic

Begbroke, Oxford, England, OX5 1RU • +44 (0)1865 842300

320 West 46th Street, 2nd Floor, New York, NY 10036, USA • +1 (1) 212 315 1111  
Suite 401, 5757 Wilshire Blvd, Los Angeles, CA 90036, USA • +1 (1) 323 549 9090  
3-55-14 Sendagaya, Shibuya-Ku, Tokyo 151-0051, Japan • +81 (0)3 5474 1144  
7 bis, rue de la Victoire, le Blanc Mesnil, Paris 93150, France • +33 (0)1 48 67 84 85  
Via Timavo 34, 20124 Milano, Italy • +39 (0)39 2328 094

Visit SSL at URL: <http://www.solid-state-logic.com>

© Solid State Logic

All Rights reserved under International and Pan-American Copyright Conventions

Solid State Logic, SSL and XLogic are trademarks of Solid State Logic

All other product names and trademarks are the property of their respective owners

No part of this publication may be reproduced in any form or  
by any means, whether mechanical or electronic, without the  
written permission of Solid State Logic, Oxford, England

Revision 0A, May 2004  
Minor changes, November 2004  
Minor changes, June 2005

As research and development is a continual process, Solid State Logic reserves the right  
to change the features and specifications described herein without notice or obligation

E&OE

---

## Contents

1. Introduction	3
Warranty	
2. Safety Considerations	4
Definitions	
Electrical Safety Warnings	
Installation	
3. Installation	6
Supplied Parts	
Tools Required	
Procedure	
4. Operation	11
Synchronisation	
Sample Rates	
Appendices	15
A. Internal Links	
B. Connector Details	
C. Electronic Specification	
D. Physical Specification	
E. Environmental Specification	

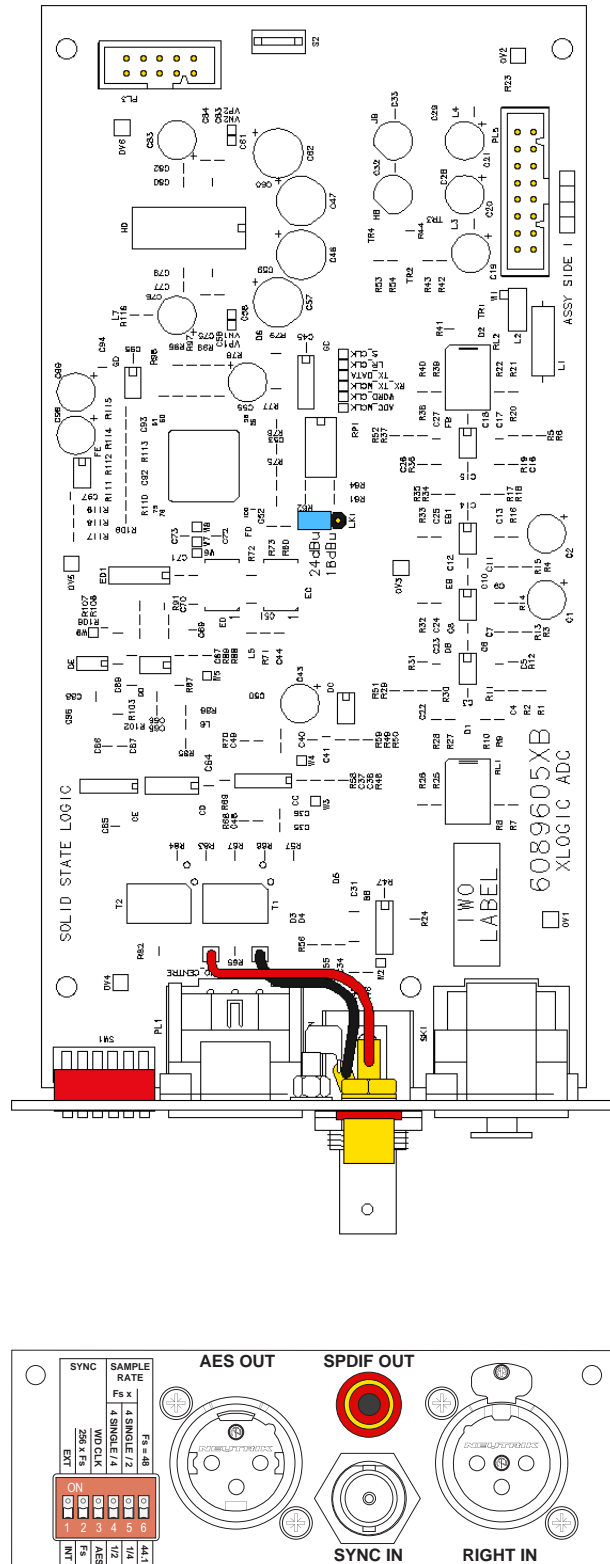

Plan (top) and elevation (lower) of the 629605 Channel ADC card

## 1. Introduction

The XLogic Channel ADC card is a small PCB assembly containing a high quality 24-bit stereo ADC. The card is intended to be fitted inside the XLogic Channel unit to provide immediate A to D conversion at any of the common sample rates between 44.1kHz and 192kHz. The ADC can be synchronised either to internal crystal or an external word clock or AES/SPDIF sync source. Digital output from the card is provided in both balanced AES and un-balanced SPDIF formats.

Because the XLogic Channel unit is a mono unit, a second balanced line-level input to the ADC card is provided. This allows connection of, for example, a second XLogic Channel unit to enable full use of the AES/SPDIF stereo data stream.

The object of this manual is to provide purchasers of the XLogic Channel ADC card with information in the following areas:

- Safety considerations
- Installation instructions
- Operational instructions
- Connector pin-outs
- Specifications and physical dimensions

### *Please Note*

*The XLogic Channel ADC card is a hardware upgrade for the XLogic Channel unit – it must be installed before it can be used. Full instructions to achieve this are provided within this document, however, if you are unsure about performing this please contact your local Solid State Logic distributor who will be happy to arrange to install it for you. Do note that a charge may be levied for this service.*

## Warranty

The warranty period for this card is 12 months from date of purchase.

### **In Warranty Repairs**

In the event of a fault during the warranty period the unit must be returned to your local distributor who will arrange for it to be shipped to Solid State Logic for repair. All units should be shipped to Solid State Logic in their original packaging. Solid State Logic can not be held responsible for any damage caused by shipping units in other packaging. In such cases Solid State Logic will return the unit in a suitable box, which you will be charged for. Please do not send manuals, power leads or any other cables - Solid State Logic can not guarantee to return them to you. Please also note that warranty returns will only be accepted as such if accompanied by a copy of the receipt or other proof of purchase.

### **Out of Warranty Repairs**

In the event of a fault after the warranty period has expired, return the unit in its original packaging to your local Solid State Logic distributor for shipment to Solid State Logic. You will be charged for the time spent on the repair (at Solid State Logic's current repair rate) plus the cost of parts and shipping.

## 2. Safety considerations

This section contains definitions and warnings, and practical information to ensure a safe working environment. Please take time to read this section before undertaking any installation work.

### Definitions

#### *'Maintenance'*

All maintenance must be carried out by fully trained personnel. *Note: it is advisable to observe suitable ESD precautions when maintenance to any part is undertaken.*

#### *'Non-User Adjustments'*

Adjustments or alterations to the equipment may affect the performance such that safety and/or international compliance standards may no longer be met. Any such adjustments must therefore only be carried out by fully trained personnel.

#### *'Users'*

This equipment is designed for use solely by engineers and competent operators skilled in the use of professional audio equipment.

#### *'Environment'*

This product is a Class A product intended to form an integrated component part of a professional audio recording, mixing, dubbing, film, TV, radio broadcast or similar studio wherein it will perform to specification providing that it is installed according to professional practice.

### **Electrical Safety Warning**

When installing or servicing any item of Solid State Logic equipment with power applied, when cover panels are removed, HAZARDOUS CONDITIONS CAN EXIST.

These hazards include:

- High voltages
- High energy stored in capacitors
- High currents available from DC power busses
- Hot component surfaces

Any metal jewellery (watches, bracelets, neck-chains and rings) that could inadvertently come into contact with uninsulated parts should always be removed before reaching inside powered equipment.

## **Installation**

### **Voltage Selection and Fusing**

The XLogic Channel ADC card is fitted internally to the XLogic Channel unit and so does not require a mains supply.

### **CE Certification**

Modifying any of the metalwork of the XLogic Channel unit to which this assembly is fitted in any way may adversely affect the CE certification status of the product.

### **FCC Certification**

The XLogic Channel unit, with an ADC card fitted, has been tested and found to comply with the limits for a Class A digital device, pursuant to part 15 of the FCC Rules. These limits are designed to provide reasonable protection against harmful interference when the equipment is operated in a commercial environment. This equipment generates, uses, and can radiate radio frequency energy and, if not installed and used in accordance with the instruction manual, may cause harmful interference to radio communications. Operation of this equipment in a residential area is likely to cause harmful interference in which case the user will be required to correct the interference at his own expense.

*The above certifications are valid provided the ADC card is fitted to an XLogic Channel assembly, as instructed within this document.*

### 3. Installation





This section details how to install the XLogic Channel ADC card in an XLogic Channel unit. Before you begin, please consider these points:

- Carefully read through these instructions first.
- Check that all of the component parts of the kit are present.
- Check that you have the required tools to hand before attempting installation.
- Consider if you need to adjust the operating level of the card. There are two options, set by an internal jumper:

+24dBu (position '1-2')    0dBu ≈ -24dB FS (SMPTE standard and factory default)  
 +18dBu (position '2-3')    0dBu ≈ -18dB FS (EBU standard)

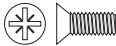
#### Supplied Parts

The following hardware is supplied with the XLogic Channel ADC Card kit:

Qty	Item	Part Number & Description	Notes
10		51DD20CB - Screw M3 x 6mm Csk Pozi Zp	Spares, for the top cover...
6		51DD25CB - Screw M3 x 6mm Pan Pozi Zp	ADC Card fixings
4		51DDNH5Z - Washer M3 Fibre	Internal ADC Card fixings
2		51DDNQ5B - Washer M3 Crinkle Shakeproof Zp	External ADC Card fixings

Also included in this kit are one of each of the following:

- 629605X1 - S/A XLogic ADC

This card should be left in its sealed, anti-static bag, until you are ready to install it.

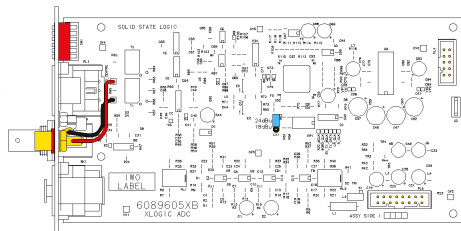

Along with the card there should also be a short ribbon cable (either loose or plugged into PL5 on the ADC card).

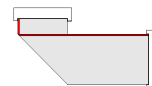

- 82S6XL070A - XLogic Channel ADC Installation Guide (this document)

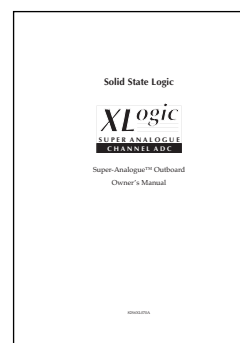



## Tools Required

Other than any tools which may be required to remove the XLogic Channel unit from any racking or studio furniture, the following tool is all that is required to install this card:

Qty	Part No.	Description	Notes
1	80C2CECC	1-point pozi-drive screwdriver	<i>This is not a 'philips' screwdriver!</i>

Do however, please note the following:

- The geometry of 'philips' and 'pozi-drive' screws and screwdrivers are subtly different and so the two types of screw and screwdriver are not inter-changeable. It is however normally quite simple to differentiate between the two types of screwdriver as the tip of a 'pozi-drive' screwdriver is quite blunt and has additional 'flutes' between each of the four blades that make up the head, as shown in the illustration to the right – a 'philips' screwdriver will be missing the flutes and has a much sharper tip.
- Most 'pozi-drive' screws have an echo of the additional 'flutes' marked on the head of the screw - take a look at the illustrations opposite and the screws that we have supplied.
- The tip of any screwdriver should firmly locate in the screwhead – if it does not then it is either the wrong type, the wrong size or worn out.
- If you neither possess nor can obtain a 1-point pozi-drive screwdriver locally, it should be possible to obtain one from your local Solid State Logic distributor.

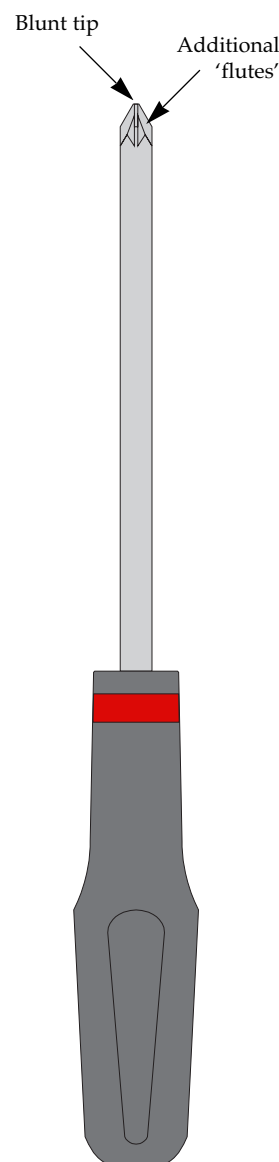

## Procedure

Remove the XLogic Channel unit from any racking or studio furniture, and place it on a suitable clean, flat work surface. Ensure that the work area is adequately illuminated and then proceed as follows:

1. Using a 1-point pozi-drive screwdriver, remove the 15 M3 x 6mm csk screws which secure the top cover to the unit. Lift the cover off and place it safely to one side.

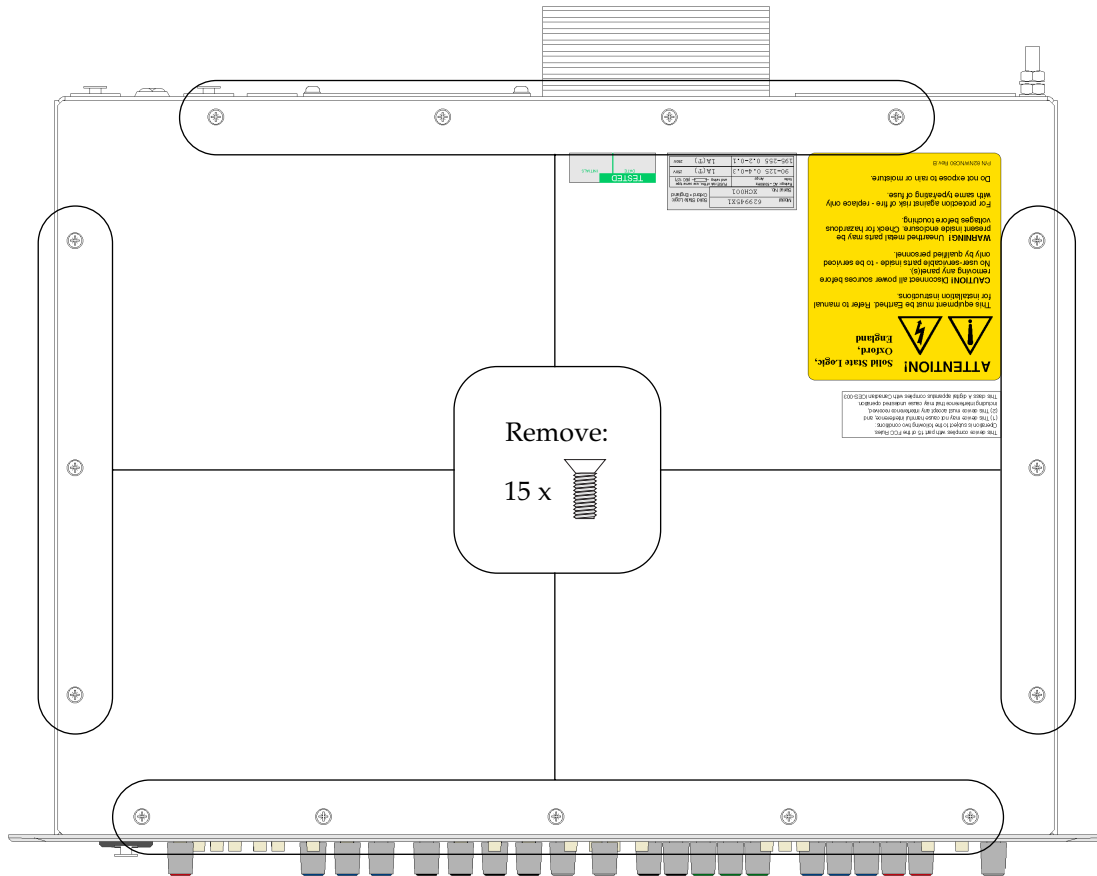

2. Turn the unit around and using the same screwdriver, remove the two M3 x 6mm panhead screws which fix the ADC blanking plate to the rear of the unit. The blank plate, screws and washers removed can be discarded although it is recommended that they be retained in case it is found necessary to remove the ADC card at a later date.

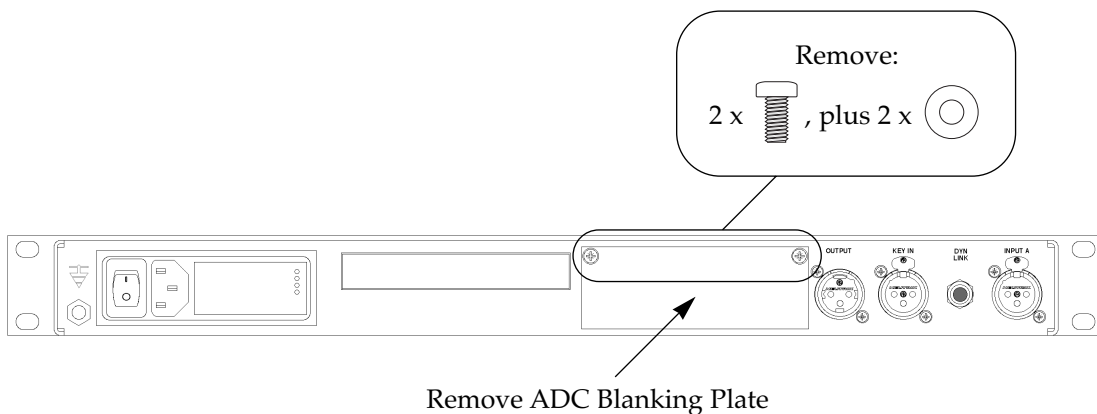

- Remove the ADC card from its sealed anti-static bag, either fold back or remove and place to one side the short ribbon cable attached to PL5. Slide the ADC card through the aperture in the rear of the XLogic unit that was revealed in step 2. above. It may be necessary to lift the 'OUTPUT' and 'Gnd' (S1) cables on the main PCB to avoid them snagging under the ADC card.

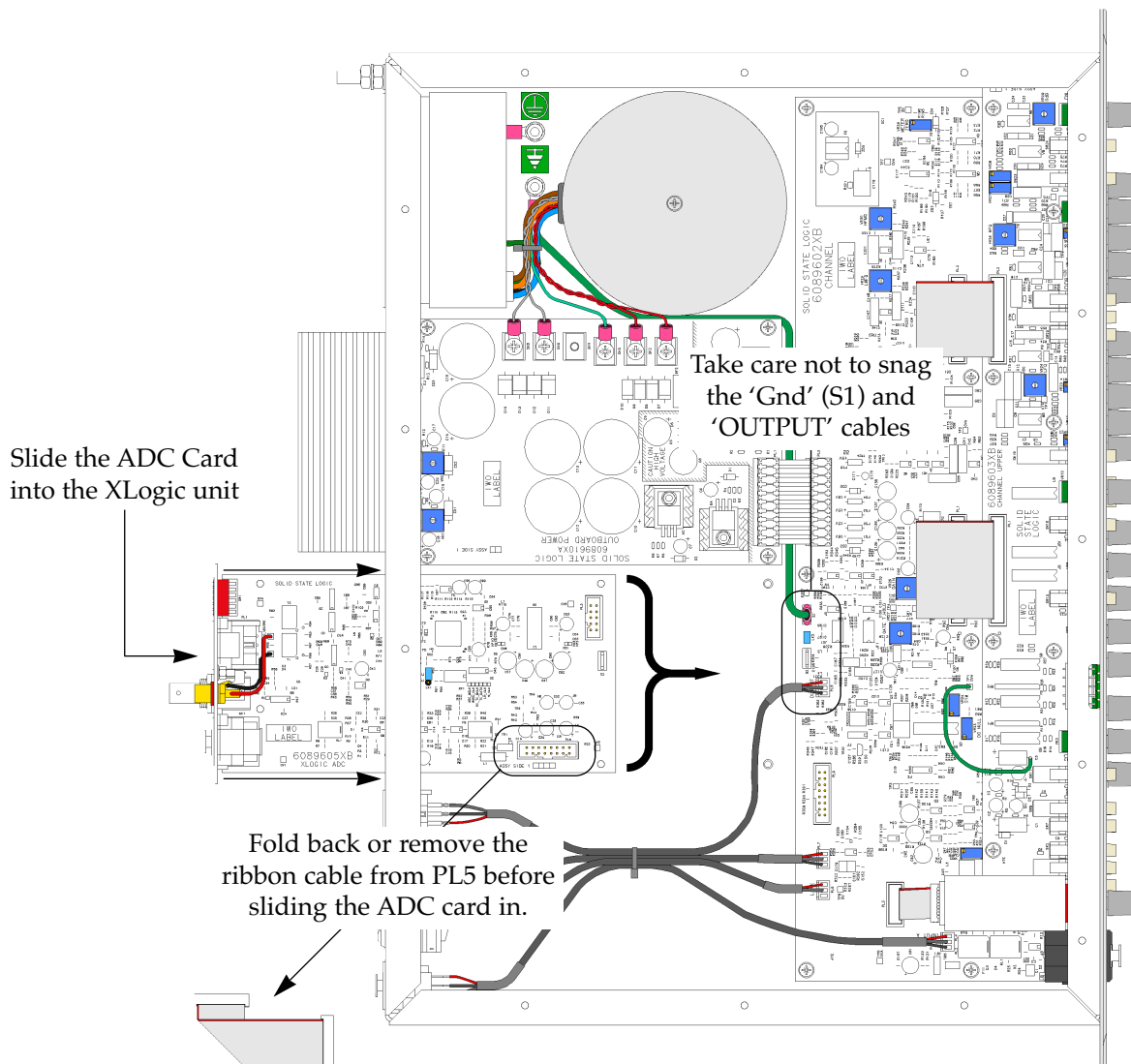

- The ADC card is retained in the XLogic unit by a total of six screws; two for the rear plate and four for the PCB. Loosely fit four M3 x 6mm panhead screws and fibre washers in the PCB holes, followed by two M3 x 6mm panhead screws and wave washers to the rear panel.

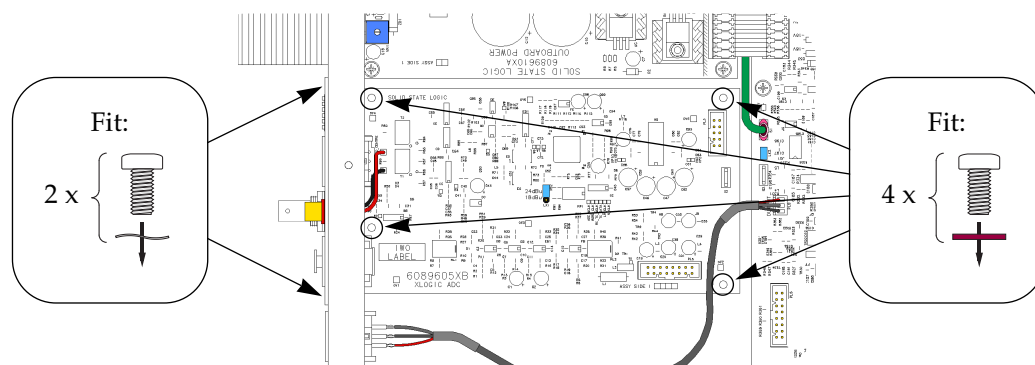

5. Check that the rear plate of the ADC card is flush to the rear panel of the XLogic unit and tighten the six screws; these screws need only be lightly tightened – the ADC card isn't going to be escaping out of the box by itself...
6. Connect the short ribbon cable removed in step 3. above between PL5 on the ADC card and PL5 on the main PCB. Be sure to push these connectors fully home; they have about 5mm of travel and there should be a light 'click' as they are seated.

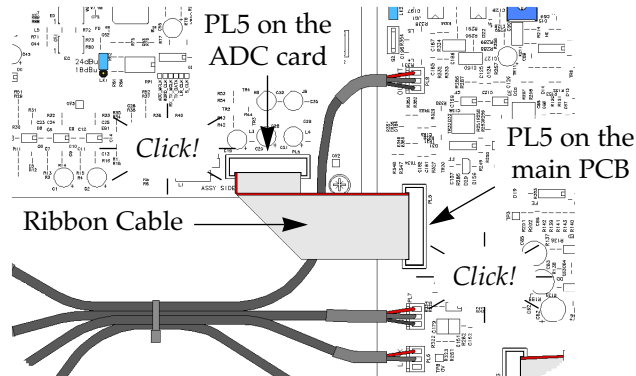

7. Check that link LK1 on the ADC card is set to the correct position – if in doubt, leave it at the factory (+24dBu) setting.

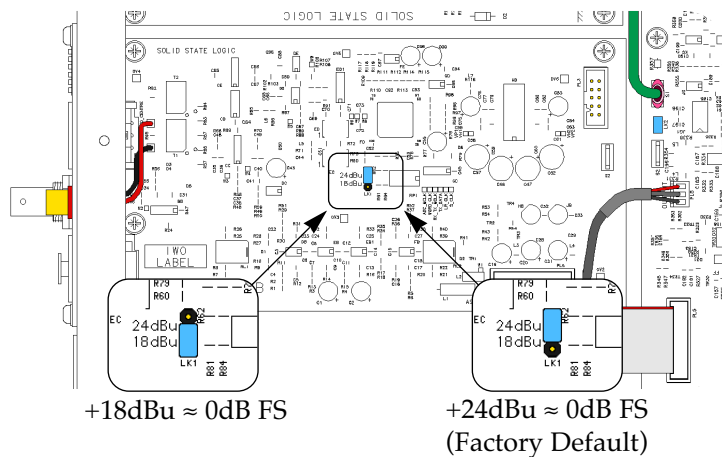

8. Refit the top cover to the XLogic unit and replace the 15 M3 x 6mm Csk screws – we have supplied a few replacements if any were damaged (or missing). Like the ADC card, these screws should not be over-tightened - they should be little more than finger tight. When the top cover is fitted, the test and warning labels should all be visible - if they are not, you have put it on upside down!
9. Before refitting the XLogic unit to any racking or studio furniture it would be prudent to check it for correct operation – Section 4. of this document details the operational features of the ADC card.

## 4. Operation

On the rear panel of the ADC card are four sockets and one multi-position DIP switch. Their functions are as follows:

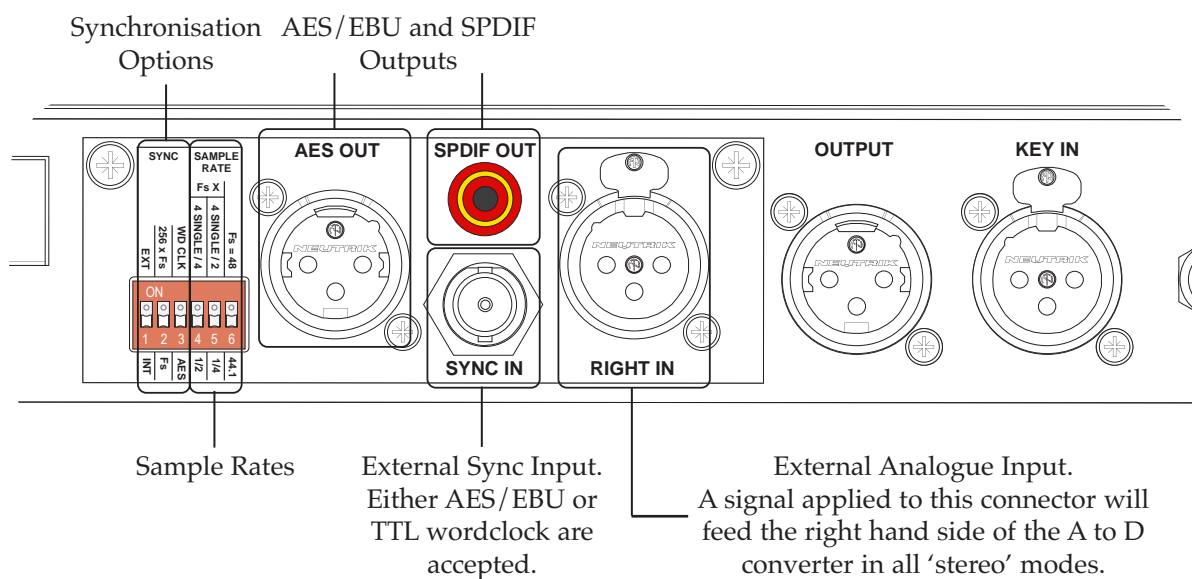

The front panel of the XLogic Channel unit carries no controls associated with the ADC card although it does have a 'Lock' indicator, located immediately below the 'Power' indicator. The various states of this indicator are as follows:

State	Function
Off	The ADC card is not locked.
Yellow	The ADC card is set to internal sync.
Red	The ADC card is set to external sync and is locked.

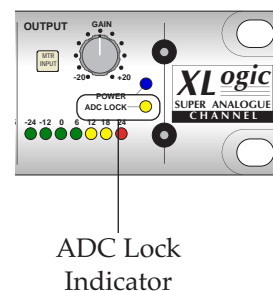







### Synchronisation

There are four possible synchronisation options, selected with switches 1 to 3 as follows:

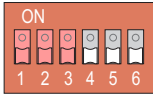
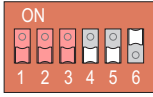
Function	Switch(es)	Detail
Internal sync		In this mode, with switch 1 'off' (down), the ADC card will free-run at the sample rate determined by the setting of switches 4 to 6 (see over leaf).
AES sync		With switches 1 and 3 set this way, an external un-balanced (75Ω) AES sync source may be used – switches 4 to 6 will need to be set to match the nominal rate being applied.
Word Clock		In this mode the ADC card will lock to an external TTL level word clock at any nominal sample rate between 44.1kHz and 192kHz – again, set switches 4 to 6 to match the nominal rate being applied.
'Super Clock'		With switches 1 to 3 all set 'on' (up), the card will synchronise to a 256x 'Super Clock' as provided from ProTools™ – switches 4 to 6 should be set to match the nominal rate being used (sample rates greater than 96kHz are <i>not</i> supported).

## Sample Rates

There are eight possible preset sample rate options ranging between 44.1kHz and 192kHz. The different rates are selected with switches 4 to 6 as follows:

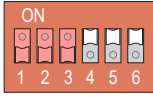
Sample Rate	Switch(es)	Detail
44.1kHz		With all three switches 'off' (down), this sets the ADC to run at 44.1kHz stereo. For external sync at this rate, the applied AES or Word Clock sync should be 44.1kHz whilst 'Super Clock' should be 11.2896MHz.
48kHz		This sets the ADC to run at 48kHz stereo. For external sync at this rate, the applied AES or Word Clock sync should be 48kHz whilst 'Super Clock' should be 12.2880MHz.
88.2kHz		This sets the ADC to run at 88.2kHz stereo. For external sync at this rate, the applied AES or Word Clock sync should be 88.2kHz whilst 'Super Clock' should be 22.5792MHz.
96kHz		This sets the ADC to run at 96kHz stereo. For external sync at this rate, the applied AES or Word Clock sync should be 96kHz whilst 'Super Clock' should be 24.5760MHz.
176.4kHz		This sets the ADC to run at 176.4kHz stereo. For external sync at this rate, the applied AES or Word Clock sync should be 176.4kHz – 'Super Clock' is not supported.
192kHz		This sets the ADC to run at 192kHz stereo. For external sync at this rate, the applied AES or Word Clock sync should be 192kHz – 'Super Clock' is not supported.
176.4kHz mono		This sets the ADC to run at 176.4kHz in mono or 'two wire' mode. In this mode only a single channel of data is available and so the second analogue input is not available. For external sync at this rate, the applied AES sync should be 88.2kHz or Word Clock at 176.4kHz – 'Super Clock' is not supported.
192kHz mono		With all three switches 'on' (up), this sets the ADC to run at 192kHz in mono or 'two wire' mode. In this mode only a single channel of data is available and so the second analogue input is not available. For external sync at this rate, the applied AES sync should be 96kHz or Word Clock at 192kHz – 'Super Clock' is not supported.

**Notes**

- The external analogue input is DC coupled and electronically balanced. It will feed the right hand side of the A to D converter in all of the 'stereo' AES modes – when the ADC card is set to run at either 176.4kHz mono or 192kHz mono this input can not be used.
- The AES/EBU and SPDIF digital outputs are independant of each other. They are both transformer isolated.
- The Sync Input is a 75Ω BNC and will accept either TTL wordclock ( $\approx 5V$  pk-pk) or unbalanced 75Ω AES/EBU ( $\approx 1V$  pk-pk). Conversion from balanced to un-balanced AES/EBU is best achieved with a third-party in-line transformer. These are widely available – your local Solid State Logic distributor should be able to supply these. Alternatively, a standard 110Ω balanced feed can be used, albeit at the expense of increased jitter due to the level/impedance mis-match.
- The 'Lock' indicator shows that the ADC card is locked to the selected sync source. Whilst this also implies that the correct sample rate has been selected on the DIP switches on the rear of the unit, it does not necessarily mean that valid AES/EBU data is being produced.





## Appendix A – Internal Links

There is one internal link on the ADC card:

LK1	Sets the operating level as follows: 1-2 +24dBu $\approx$ 0dB FS ( <i>factory default</i> ) 2-3 +18dBu $\approx$ 0dB FS
-----	-------------------------------------------------------------------------------------------------------------------------------

## Appendix B – Connector Details

<b>Right In</b>	
Location:	Rear Panel
Conn' Type:	XLR Female
<i>Pin</i>	<i>Description</i>
1	Chassis
2	Audio +ve
3	Audio -ve

<b>Sync In</b>	
Location:	Rear Panel
Conn' Type:	75 $\Omega$ BNC
<i>Pin</i>	<i>Description</i>
Tip	Signal
Sleeve	Chassis

<b>AES Out</b>	
Location:	Rear Panel
Conn' Type:	XLR Male
<i>Pin</i>	<i>Description</i>
1	Chassis
2	Signal +ve
3	Signal -ve

<b>SPDIF Out</b>	
Location:	Rear Panel
Conn' Type:	RCA Phono
<i>Pin</i>	<i>Description</i>
Tip	Signal
Sleeve	Chassis

## Appendix C – Performance Specification

Following are audio performance specification figures for the XLogic Channel ADC card, when fitted to an XLogic Channel unit. No other Solid State Logic products, including the XLogic Channel unit with which this card operates, are covered by this document and the performance of other Solid State Logic products can not be inferred from the data contained herein.

### Measurement Conditions

For all of these measurements, signal for the left hand channel is applied via PL5 and for the right hand channel via SK1. Measurements are taken from the AES output. For all measurements the gain of the ADC card is set at +24dBu  $\approx$  0dB FS.

### Measurement References

Unless otherwise specified the references used in this specification are as follows:

- Reference frequency: 1kHz
- Reference level: 0dB FS (+24dBu)
- Source impedance of Test Set: 50 $\Omega$
- Unweighted measurements are specified as 22Hz to 22kHz band limited RMS and are expressed in units of dB FS
- All distortion measurements are bandwidth limited in the digital domain at no more than half the sample frequency specified and are expressed as a percentage
- Jitter is quoted in terms of 'Unit Interval' where 1 UI = Sample Period/128 (ref. AES-3-1995)
- Unless otherwise quoted all figures have a tolerance of  $\pm$ 0.5dB or 5%

### ADC Performance

Gain	Link selectable between +18dBu $\approx$ 0dB FS and +24dBu $\approx$ 0dB FS
Input Impedance	10k $\Omega$ @ +24dBu, 5k $\Omega$ @ +18dBu
THD + Noise	< 0.0035% from 20Hz to 20kHz, irrespective of sample rate
Frequency Response	$\pm$ 0.05dB from 20Hz to 20kHz @ 44.1kHz $\pm$ 0.05dB from 20Hz to 40kHz @ 96kHz
Usable Dynamic Range	> 110dB
Common Mode Rejection	> 55dB from 20Hz to 20kHz
Resolution	24bit
Jitter	< 0.025 UI (700Hz to 100kHz filter, internal sync)
Group Delay	64 samples, irrespective of sample rate

## Appendix D – Physical Specification \*

Depth:	180mm/7.0 inches PCB only 203mm/8.0 inches including rear panel and connectors
Height:	36mm/1.4 inches including rear panel
Width:	90mm/3.5 inches PCB only 100mm/3.9 inches including rear panel
Weight:	150g/5.5 ounces
Boxed size:	190mm x 290mm x 70mm (7.5" x 11.5" x 2.5")
Boxed weight:	350g/12 ounces

\* All weights and dimensions are approximate

## Appendix E – Environmental Specification

Temperature	Operating:	5 to 30 Deg. C
	Non-operating:	-20 to 50 Deg. C
	Max. Gradient:	15 Deg. C/Hour
Relative Humidity	Operating:	20 to 80 %
	Non-operating:	5 to 90 %
	Max. wet bulb:	29 Deg. C (non-condensing)
Vibration	Operating:	< 0.2 G (3 - 100Hz.)
	Non-operating, power off:	< 0.4 G (3 - 100Hz.)
Shock	Operating:	< 2 G (10mSec. Max.)
	Non-operating:	< 10 G (10mSec. Max.)
Altitude	Operating:	0 to 3000m (above sea level)
	Non-operating:	0 to 12000m

## Notes